

DRAW SHEAR FORCE AND BENDING MOMENT DIAGRAM

Q.1.

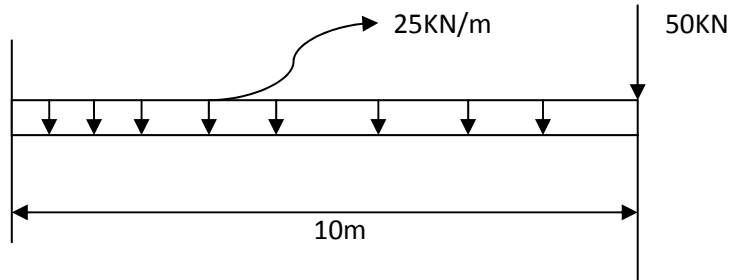

Q.2.

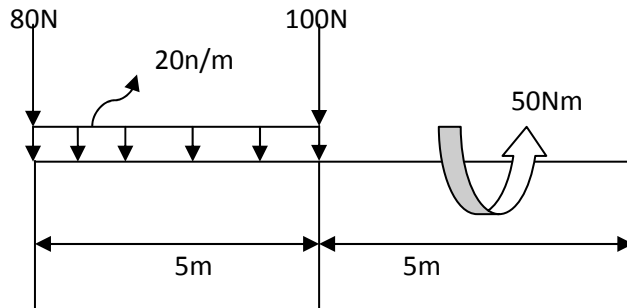

Q.3.

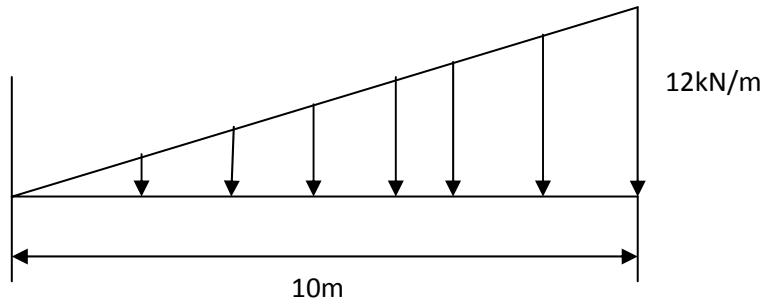

Q.4.

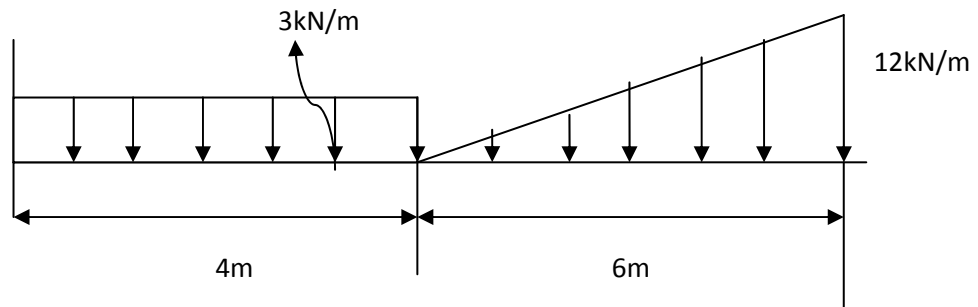

Q.5. Draw the load diagram and bending moment diagram from the given SFD

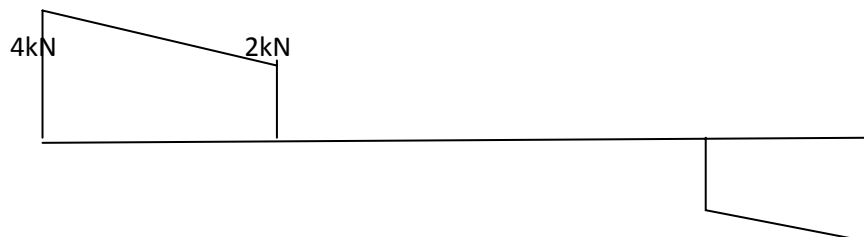

SHEAR FORCE AND BENDING MOMENT

Shear force at a section in a beam is the normal force that is trying to shear off the section and is obtained as the algebraic sum of the forces acting normally to the axis of the beam to the right or left of the section.

Bending moment at a section in a beam is the moment that is trying to bend the beam and is obtained as the algebraic sum of the moments of all forces acting about the section acting either to the right or left of the section.

SIGN CONVENTION

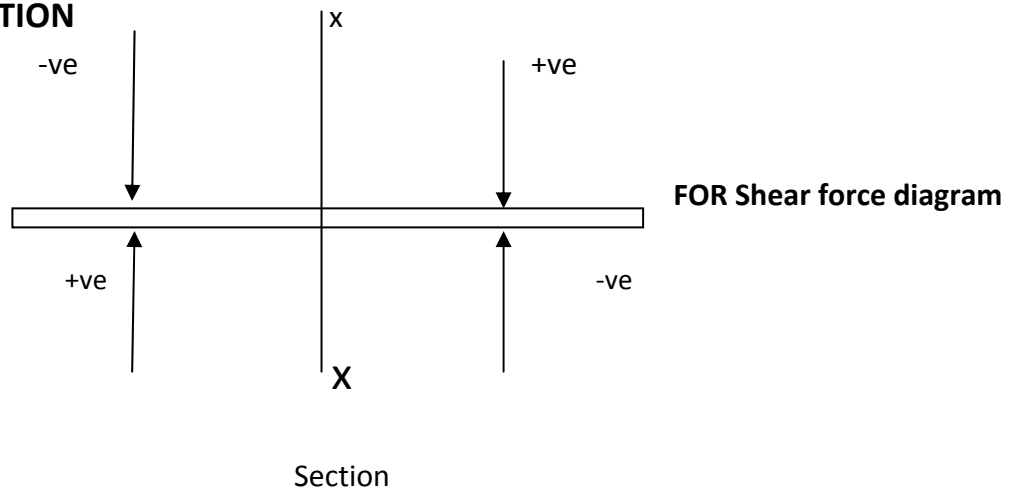

NOTE:

1. The point at which shear force becomes zero , bending moment will be maximum at that point
2. The point at which bending moment becomes zero or the point at which bending moment changes its sign is called point of contraflexure.

RELATION BETWEEN SHEAR FORCE, BENDING MOMENT & INTENSITY OF LOADING

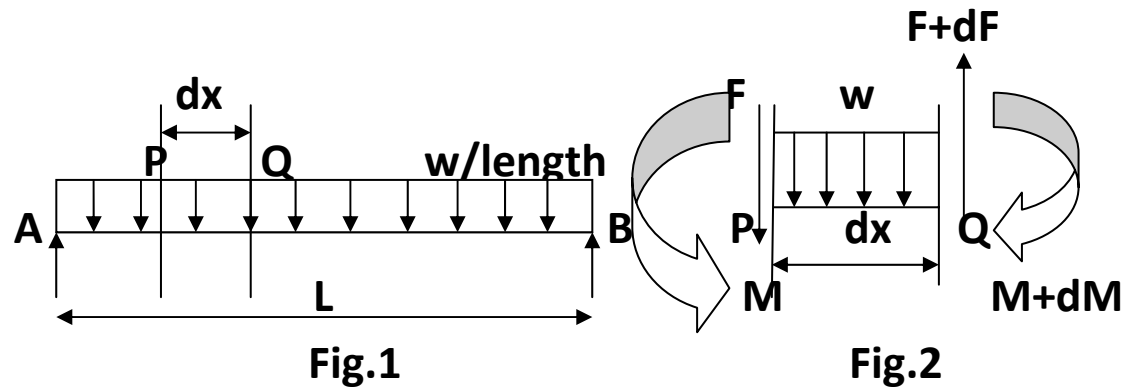

Consider a section at a distance of x from A having length dx
 From Fig.2: $F+dF-F-wdx=0$ or $dF/dx=w$
 Taking moment about P : $-M+M+dM+wdx \cdot dx/2+(F+dF)dx=0$
 Or $dM/dx=-F$

A **beam** is a structural element that is capable of withstanding load primarily by resisting bending. The bending force induced into the material of the beam as a result of the external loads, own weight and external reactions to these loads is called a bending moment.

TYPES OF BEAM

1. Cantilever types of beam

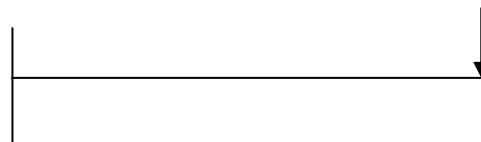

2. Simply supported beam

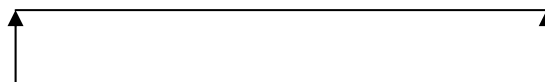

3. Overhanging beam

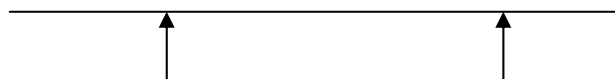

UNIT:II

Mr.Nurul Hassan

DRAW SHEAR FORCE AND BENDING MOMENT DIAGRAM

Q.1.

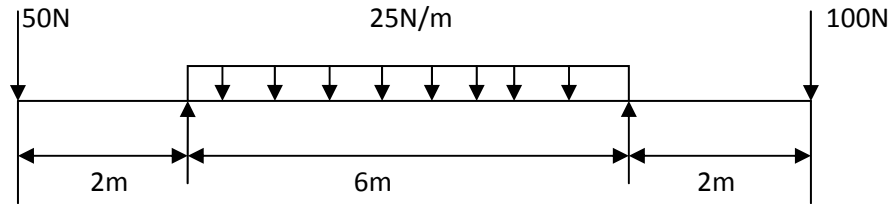

Q.2.

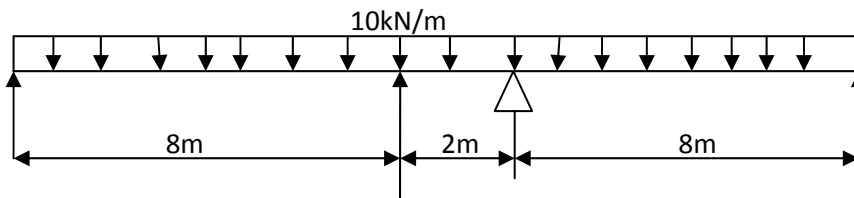

Q.3.

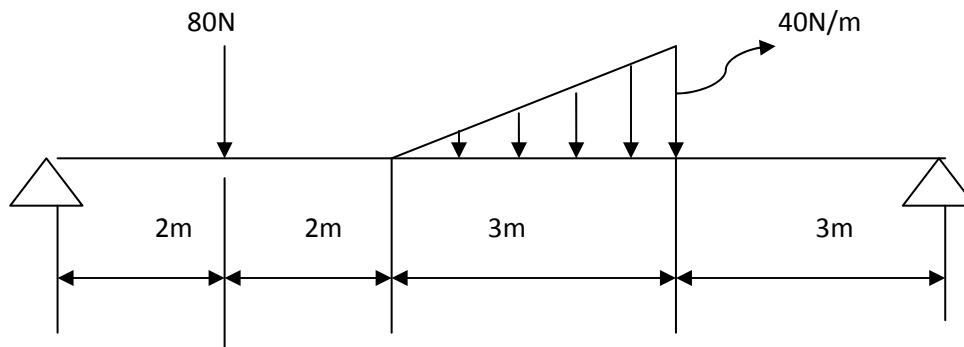

Q.4.

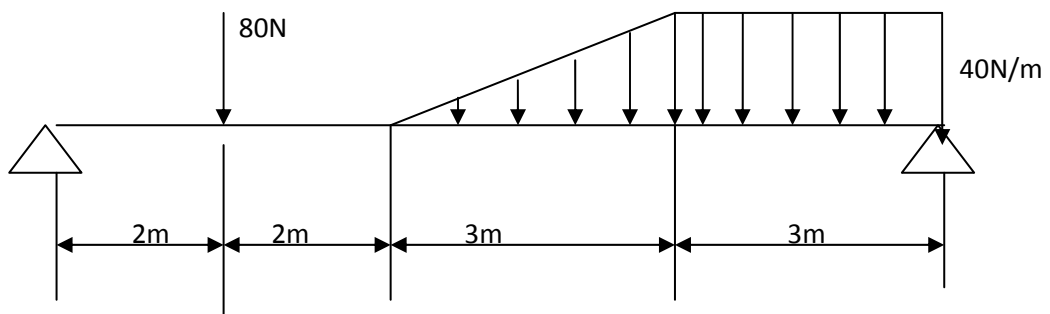

Q.1.

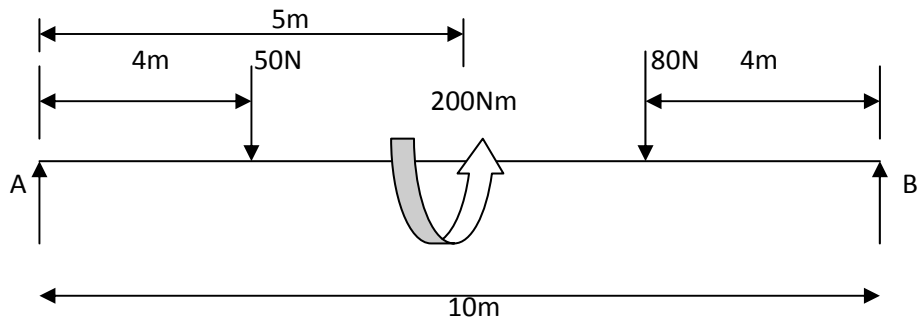

Q.2.

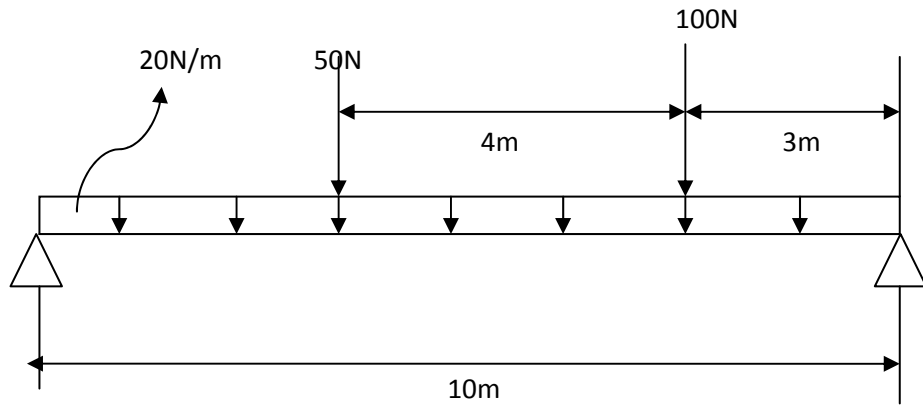

Q.3.

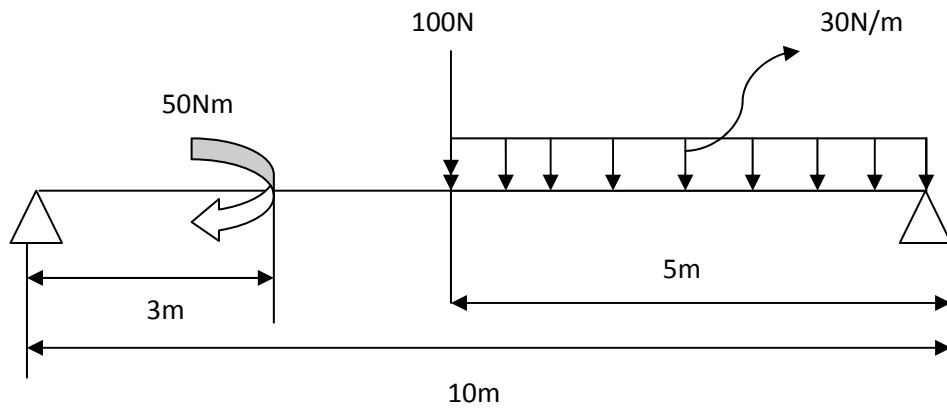

Q.4.

